

UNI-Spray™ Series

The Universal Spray Head

Primary Application

The UNI-Spray™ is designed for those applications where flexibility and convenience are primary considerations. These reliable, compact spray heads are shipped with or without pre-installed Variable Arc Nozzles (VANs) that are adjustable from 0° to full circle operation, saving hours of installation time, effort and money.

Features

- Pressure-activated, wiper seal prevents excessive flow-by and water waste. Keeps debris from entering upon retraction.
- Durable stem ratchet allows for quick and easy nozzle pattern alignment.
- Internal parts removable from the top of the sprinkler for easy servicing.
- Small exposed cover makes the unit virtually invisible for more attractive landscapes.
- Rugged cover and body provide durability in high pressure and surge conditions.
- Plastic and stainless steel materials resist corrosion.
- VAN nozzle and screen are easily removable for flushing.
- UNI-Spray™ accepts all Rain Bird® Series nozzles and accessories, which simplifies inventory management.
- Optional field installable Seal-A-Matic™ check valve prevents low head drainage up to five feet (1,5 m) of elevation difference.
- Three-year trade warranty.

Operating Range

- Spacing: 10 VAN Series: 8 to 10 feet (2,4 to 3,0 m)
- 12 VAN Series: 10 to 12 feet (3,0 to 3,7 m)
- 15 VAN Series: 12 to 15 feet (3,7 to 4,6 m)
- 18 VAN Series: 14 to 18 feet (4,3 to 5,5 m)
- Pressure: 15 to 70 psi (1,0 to 4,8 bar)
- Optimum Pressure: 30 psi (2 bar)
- Adjustable nozzle arc range: 0°-360°

Specifications

- Flow-by: 0 at 10 psi (0,75 bar) or greater; 0.50 Gpm (0,11 m³/h; 0,03 l/s) otherwise

Dimensions

- ½" (15/21) NPT female threaded inlet
- Body height:
- US-200: 3¾" (9,6 cm)
- US-400: 5¾" (15 cm)
- Exposed surface diameter: 1¼" (3,2 cm)

Models*

- US-400: 4" pop-up height (10,3 cm)
- US-410 VAN: 4" pop-up height (10,3 cm) with 10-VAN attached
- US-212 VAN: 2" pop-up height (5,1 cm) with 12-VAN attached
- US-412 VAN: 4" pop-up height (10,3 cm) with 12-VAN attached
- US-215 VAN: 2" pop-up height (5,1 cm) with 15-VAN attached
- US-415 VAN: 4" pop-up height (10,3 cm) with 15-VAN attached
- US-418 VAN: 4" pop-up height (10,3 cm) with 18-VAN attached
- US-SAM: UNI-Spray™ check valve

*The UNI-Spray™ sprinkler body accepts all Rain Bird nozzles.

For performance data of other Rain Bird nozzles, see the Landscape Irrigation Products Catalog-Sprays Section.



How To Specify

US - 4 12 VAN
 Model UNI-Spray Nozzle Series Pattern
 Pop-up Height
 2: 2"
 4: 4"

This specifies a UNI-Spray body with a 4" (10,3 cm) pop-up height; 12 foot (3,6 m) variable arc nozzle (VAN)

Performance Installation Method

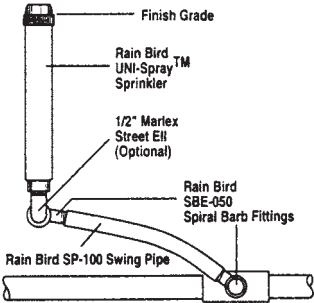

Turning the radius reduction screw may be required to achieve catalog radius and flow when the arc is set at less than full circle.



Rain Bird Corporation

6991 E. Southpoint Road
Tucson, AZ 85756
Phone: (520) 741-6100
Fax: (520) 741-6522

Rain Bird Technical Services

(800) RAINBIRD (1-800-724-6247)
(U.S. and Canada)

Rain Bird Corporation

970 West Sierra Madre Avenue
Azusa, CA 91702
Phone: (626) 812-3400
Fax: (626) 812-3411

Specification Hotline

800-458-3005 (U.S. and Canada)

Rain Bird International, Inc.

1000 West Sierra Madre Ave.
Azusa, CA 91702
Phone: (626) 963-9311
Fax: (626) 852-7343

The Intelligent Use of Water™
www.rainbird.com



► Diseño compacto

La tapa pequeña hace que la unidad sea virtualmente invisible para lograr jardines más atractivos.

► Máxima compatibilidad

Diseñados para su utilización con todas las toberas Rain Bird, incluidas toberas giratorias, Serie U, MPR, HE-VAN, VAN y Serie SQ.

► Fiabilidad inigualable

Construidos con materiales resistentes, incluido acero inoxidable resistente a la corrosión, para garantizar una prolongada vida útil del producto, incluso en condiciones de alta presión.

Difusores Serie UNI-Spray™

Difusores compactos y fiables para cualquier aplicación



Instalados en todo el mundo, los difusores de la Serie UNI-Spray son la mejor elección para todas aquellas instalaciones que exigen poca altura y el difusor más oculto.

Fabricados con materiales resistentes y elegidos por su extraordinaria fiabilidad, los difusores UNI-Spray ofrecen la garantía de un perfecto funcionamiento durante muchos años. Con una amplia variedad de toberas compatibles, los difusores UNI-Spray pueden regar con una alta eficiencia zonas pequeñas y medianas de césped y arbustos.

Se dispone de una válvula antidrenaje Seal-A-Matic™ (SAM) integrada para evitar las costosas pérdidas de agua y el drenaje en los puntos más bajos.

Materiales fiables y resistentes

- La junta de estanqueidad activada por la presión evita la pérdida de agua (caudal paralelo) y no permite la entrada de suciedad cuando se retrae el difusor.
- La tapa y cuerpo resistentes garantizan la durabilidad en condiciones de alta presión.
- Los materiales de plástico y acero inoxidable son resistentes a la corrosión.

Amplia variedad de opciones de toberas

- Seleccione las toberas MPR y VAN para lograr el rendimiento más económico con pluviometrías estándar.
- Seleccione las toberas HE-VAN y Serie U para obtener la máxima eficiencia con pluviometrías estándar.
- Seleccione las toberas giratorias Serie R-VAN para lograr la máxima eficiencia con pluviometrías bajas.

Válvula antidrenaje opcional instalable en difusores ya instalados

- Ahorra agua eliminando el drenaje en los puntos más bajos de hasta 1,5 m (5 pies) de diferencia de altura.
- Reduce el desgaste de los componentes del sistema minimizando el golpe de ariete durante la puesta en marcha.
- Se evitan los daños en los jardines causados por inundaciones y erosión.

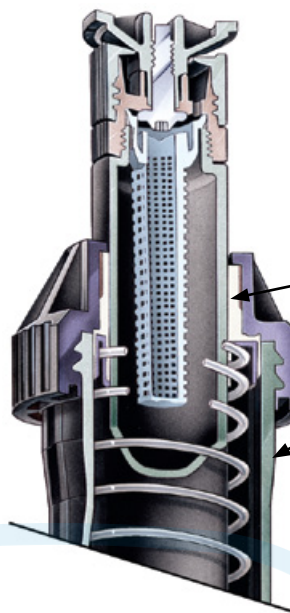

Junta de estanqueidad activada por presión

Tapa y cuerpo resistentes



Tamaño compacto y fácil instalación

- Altura de elevación de 5,1 cm (2") y 10,2 cm (4") para diferentes alturas de césped y jardines.
- Disponible con toberas VAN de 3 m (10'), 3,7 m (12'), 4,6 m (15') y 5,5 m (18') preinstaladas.
- La tapa pequeña hace que la unidad sea virtualmente invisible para lograr jardines más atractivos.



► Design compact

Grâce à leur couvercle profilé, les tuyères UNI-Spray sont quasiment invisibles une fois installées.

► Compatibilité maximale

Compatibles avec toutes les buses Rain Bird, notamment les buses rotatives, ainsi que les modèles Série U, MPR, HE-VAN, VAN et Série SQ.

► Fiabilité inégalée

Leur fabrication en matériaux durables dont l'inox, qui résiste à la corrosion, leur assure une grande longévité, même à de hautes pressions ou en conditions extrêmes.

Tuyères Série UNI-Spray™

Tuyères compactes et fiables pour une grande variété d'applications



Présentes dans les jardins du monde entier, les tuyères Série UNI-Spray sont une évidence pour tous les types d'installations exigeant que la tuyère soit la plus dissimulée possible.

Fabriquées en matériaux extrêmement robustes, les tuyères UNI-Spray offrent une grande fiabilité à long terme. Compatibles avec un large éventail de buses, elles sont performantes pour l'arrosage d'espaces de petite et moyenne dimension constitués de gazon ou d'arbustes.

Pour éviter le gaspillage d'eau en cas d'écoulement en bas de pente, un clapet anti-vidange Seal-A-Matic™ (SAM) est disponible en option.

Matériaux fiables et ultra-résistants

- Un joint racleur actionné par pression évite un écoulement excessif et un gaspillage d'eau tout en empêchant l'introduction de débris lors de la rétractation.
- La robustesse du couvercle et du corps assure une durabilité à des pressions élevées ou dans des conditions extrêmes.
- Le plastique et l'inox résistent à la corrosion.

Un large éventail de buses

- Optez pour les buses MPR et VAN si vous recherchez un tarif attractif pour une pluviométrie standard.
- Optez pour les buses HE-VAN et Série U pour des performances optimales et une pluviométrie standard.
- Optez pour les buses rotatives Série R et R-VAN pour des performances optimales et une faible pluviométrie.

Clapet anti-vidange en option

- Il permet d'économiser de l'eau en supprimant l'écoulement en bas de pente, jusqu'à 1,5m de dénivelé.
- Il limite l'usure des pièces en minimisant les coups de bélier au démarrage.
- Il met fin aux détériorations des espaces verts dues aux inondations et/ou à l'érosion.

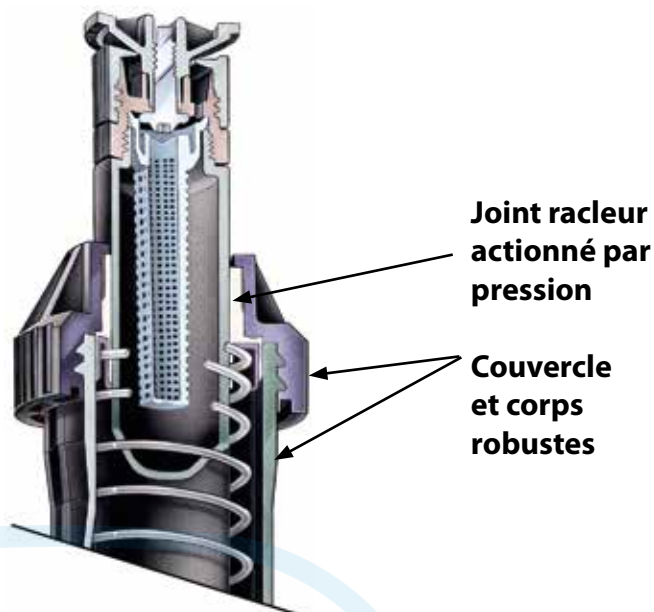

Compacte et facile à installer

- Hauteurs de soulèvement disponibles de 5 cm et 10 cm, en fonction des hauteurs du gazon ou des espaces verts.
- Proposée avec des buses VAN pré-installées 3 m, 3,70 m, 4,60 m et 5,50 m.
- Grâce à leur couvercle profilé, les tuyères UNI-Spray sont quasiment invisibles une fois installées.

FEATURES

- High-Efficiency Variable Arc (HE-VAN) nozzles have even coverage that allows you to shorten run times by up to 35%, while still maintaining a healthy lawn. HE-VAN has more than a 40% even-coverage improvement over existing variable arc nozzles.
- Low-trajectory spray and large water droplets prevent misting and airborne evaporation so the right amount of water is delivered to the right place. Gentle close-in watering eliminates dry spots around the spray head.
- Unique stream pattern that throws to the exact specified radius, delivering the cleanest edge of any VAN on the market today.
- Reduced zone run times help stay within tight watering windows, conserve water and save money.
- With full adjustability from 0° to 360°, you'll be able to efficiently water landscapes of all shapes while stocking fewer nozzles.
- Matched precipitation rates allow you to install Rain Bird® HE-VAN, MPR and U-Series nozzles on the same zone.

SPECIFICATIONS

Models:

HE-VAN-08: Green top; 6' to 8' (1.8 m to 2.4 m)

HE-VAN-10: Blue top; 8' to 10' (2.4 m to 3.0 m)

HE-VAN-12: Brown top; 9' to 12' (2.7 m to 3.7 m)

HE-VAN-15: Black top; 12' to 15' (3.7 m to 4.6 m)

Radius: Adjustable, 0° to 360°

Pressure Range: 15 to 30 psi (1.03 to 2.07 bar)

Recommended Operating Pressure: 30 psi (2.1 bar)*

Spacing: 6' to 15' (1.8 to 2.4 m)

Adjustment: Tactile click keeps arc setting from drifting over time



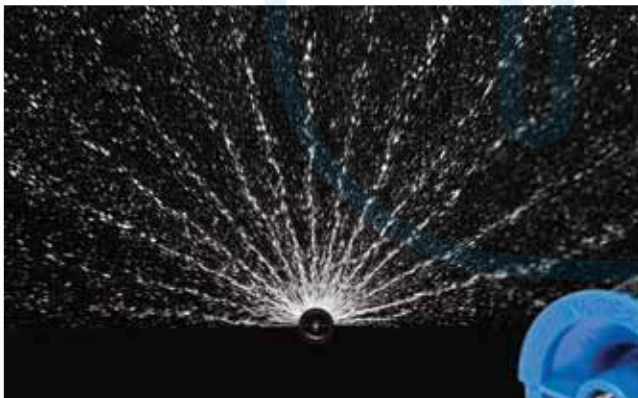

Warranty: 3-year trade warranty

HOW TO SPECIFY

HE	-	VAN	-	XX
MODEL		FEATURE		RADIUS RANGE
HE = High-Efficiency Nozzle		VAN = Variable Arc		08 = 6-8 ft 10 = 8-10 ft 12 = 9-12 ft 15 = 12-15 ft







U.S. Performance Data

8 SERIES HE-VAN — 24° TRAJECTORY																
	 360° Arc				 270° Arc				 180° Arc				 90° Arc			
Pressure (psi)	15	20	25	30	15	20	25	30	15	20	25	30	15	20	25	30
Radius (ft)	5	6	7	8	5	6	7	8	5	6	7	8	5	6	7	8
Flow (gpm)	0.83	0.96	1.07	1.17	0.62	0.72	0.80	0.88	0.41	0.48	0.53	0.59	0.21	0.24	0.27	0.29
■ Precipitation (in/h)	3.19	2.56	2.10	1.76	3.19	2.56	2.10	1.76	3.19	2.56	2.10	1.76	3.19	2.56	2.10	1.76
▲ Precipitation (in/h)	3.68	2.95	2.42	2.03	3.68	2.95	2.42	2.03	3.68	2.95	2.42	2.03	3.68	2.95	2.42	2.03

Metric Performance Data

8 SERIES HE-VAN — 24° TRAJECTORY																
	360° Arc				270° Arc				180° Arc				90° Arc			
Pressure (bar)	1.03	1.38	1.72	2.07	1.03	1.38	1.72	2.07	1.03	1.38	1.72	2.07	1.03	1.38	1.72	2.07
Radius (m)	1.52	1.83	2.13	2.44	1.52	1.83	2.13	2.44	1.52	1.83	2.13	2.44	1.52	1.83	2.13	2.44
Flow (l/m)	3.14	3.62	4.05	4.43	2.35	2.72	3.04	3.33	1.57	1.81	2.02	2.22	0.78	0.91	1.01	1.11
Flow (m ³ /h)	0.19	0.22	0.25	0.27	0.14	0.16	0.18	0.20	0.10	0.11	0.12	0.13	0.05	0.05	0.06	0.07
■ Precipitation (mm/h)	82	66	54	45	82	66	54	45	82	66	54	45	82	66	54	45
▲ Precipitation (mm/h)	95	76	62	52	95	76	62	52	95	76	62	52	95	76	62	52





U.S. Performance Data

10 SERIES HE-VAN — 27° TRAJECTORY																
	 360° Arc				 270° Arc				 180° Arc				 90° Arc			
Pressure (psi)	15	20	25	30	15	20	25	30	15	20	25	30	15	20	25	30
Radius (ft)	7	8	9	10	7	8	9	10	7	8	9	10	7	8	9	10
Flow (gpm)	1.26	1.46	1.63	1.78	0.95	1.09	1.22	1.34	0.63	0.73	0.81	0.89	0.32	0.36	0.41	0.45
■ Precipitation (in/h)	2.48	2.19	1.94	1.72	2.48	2.19	1.94	1.72	2.48	2.19	1.94	1.72	2.48	2.19	1.94	1.72
▲ Precipitation (in/h)	2.86	2.53	2.24	1.98	2.86	2.53	2.24	1.98	2.86	2.53	2.24	1.98	2.86	2.53	2.24	1.98

Metric Performance Data

10 SERIES HE-VAN — 27° TRAJECTORY																
	360° Arc				270° Arc				180° Arc				90° Arc			
Pressure (bar)	1.03	1.38	1.72	2.07	1.03	1.38	1.72	2.07	1.03	1.38	1.72	2.07	1.03	1.38	1.72	2.07
Radius (m)	2.13	2.44	2.74	3.05	2.13	2.44	2.74	3.05	2.13	2.44	2.74	3.05	2.13	2.44	2.74	3.05
Flow (l/m)	4.78	5.52	6.17	6.76	3.59	4.14	4.63	5.07	2.39	2.76	3.09	3.38	1.20	1.38	1.54	1.69
Flow (m ³ /h)	0.29	0.34	0.37	0.41	0.22	0.25	0.28	0.31	0.15	0.17	0.19	0.21	0.07	0.08	0.09	0.10
■ Precipitation (mm/h)	64	56	50	44	64	56	50	44	64	56	50	44	64	56	50	44
▲ Precipitation (mm/h)	74	65	57	51	74	65	57	51	74	65	57	51	74	65	57	51





U.S. Performance Data

12 SERIES HE-VAN — 23° TRAJECTORY																
	 360° Arc				 270° Arc				 180° Arc				 90° Arc			
Pressure (psi)	15	20	25	30	15	20	25	30	15	20	25	30	15	20	25	30
Radius (ft)	9	10	11	12	9	10	11	12	9	10	11	12	9	10	11	12
Flow (gpm)	1.67	1.93	2.16	2.37	1.25	1.45	1.62	1.77	0.84	0.97	1.08	1.18	0.42	0.48	0.54	0.59
■ Precipitation (in/h)	1.99	1.86	1.72	1.58	1.99	1.86	1.72	1.58	1.99	1.86	1.72	1.58	1.99	1.86	1.72	1.58
▲ Precipitation (in/h)	2.30	2.15	1.99	1.83	2.30	2.15	1.99	1.83	2.30	2.15	1.99	1.83	2.30	2.15	1.99	1.83

Metric Performance Data

12 SERIES HE-VAN — 23° TRAJECTORY																
	360° Arc				270° Arc				180° Arc				90° Arc			
Pressure (bar)	1.0	1.4	1.7	2.1	1.0	1.4	1.7	2.1	1.0	1.4	1.7	2.1	1.0	1.4	1.7	2.1
Radius (m)	2.7	3.0	3.4	3.7	2.7	3.0	3.4	3.7	2.7	3.0	3.4	3.7	2.7	3.0	3.4	3.7
Flow (l/m)	6.33	7.31	8.18	8.96	4.75	5.48	6.16	6.72	3.17	3.66	4.09	4.48	1.58	1.83	2.04	2.24
Flow (m³/h)	0.38	0.44	0.49	0.54	0.28	0.33	0.37	0.40	0.19	0.22	0.25	0.27	0.09	0.11	0.12	0.13
■ Precipitation (mm/h)	50.5	47.3	43.7	40.2	50.5	47.3	43.7	40.2	50.5	47.3	43.7	40.2	50.5	47.3	43.7	40.2
▲ Precipitation (mm/h)	58.3	54.6	50.4	46.4	58.3	54.6	50.4	46.4	58.3	54.6	50.4	46.4	58.3	54.6	50.4	46.4

U.S. Performance Data

15 SERIES HE-VAN — 25° TRAJECTORY																
	 360° Arc				 270° Arc				 180° Arc				 90° Arc			
Pressure (psi)	15	20	25	30	15	20	25	30	15	20	25	30	15	20	25	30
Radius (ft)	11	12	14	15	11	12	14	15	11	12	14	15	11	12	14	15
Flow (gpm)	2.62	3.02	3.38	3.70	1.96	2.27	2.53	2.78	1.31	1.51	1.69	1.85	0.65	0.76	0.84	0.93
■ Precipitation (in/h)	2.08	2.02	1.66	1.58	2.08	2.02	1.66	1.58	2.08	2.02	1.66	1.58	2.08	2.02	1.66	1.58
▲ Precipitation (in/h)	2.40	2.33	1.92	1.83	2.40	2.33	1.92	1.83	2.40	2.33	1.92	1.83	2.40	2.33	1.92	1.83

Metric Performance Data

15 SERIES HE-VAN — 25° TRAJECTORY																
	360° Arc				270° Arc				180° Arc				90° Arc			
Pressure (bar)	1.0	1.4	1.7	2.1	1.0	1.4	1.7	2.1	1.0	1.4	1.7	2.1	1.0	1.4	1.7	2.1
Radius (m)	3.4	3.7	4.3	4.6	3.4	3.7	4.3	4.6	3.4	3.7	4.3	4.6	3.4	3.7	4.3	4.6
Flow (l/m)	9.91	11.44	12.79	14.01	7.43	8.58	9.59	10.51	4.95	5.72	6.39	7.00	2.48	2.86	3.20	3.50
Flow (m³/h)	0.59	0.69	0.77	0.84	0.45	0.51	0.58	0.63	0.30	0.34	0.38	0.42	0.15	0.17	0.19	0.21
■ Precipitation (mm/h)	52.9	51.3	42.2	40.2	52.9	51.3	42.2	40.2	52.9	51.3	42.2	40.2	52.9	51.3	42.2	40.2
▲ Precipitation (mm/h)	61.1	59.3	48.7	46.5	61.1	59.3	48.7	46.5	61.1	59.3	48.7	46.5	61.1	59.3	48.7	46.5